



WARM ROOF DIVISION



Range Guide



Design Options
for PVC



- Roofline
- Cladding
- Rainwater



The Specifier's Choice for
Cellular PVC Roofline & Cladding

About Swish

- The premier brand in cellular PVC roofline and cladding
- Most comprehensive system available
- Over 40 years experience in plastics technology
- Non-lead formulation complies with UK, EEC and PVC Industry guidance on removal of lead from PVC
- Non-lead formulation will not discolour
- 20 Year Product Guarantee on White cellular PVC and 10 Years on Coloured and Foiled profiles
- Technical Services team focus on specifier requirements, providing comprehensive support.
- BBA and BSI certification (Kitemark)
- Manufactured under ISO9001
- Swish Building Products holds ISO14001 (Environmental) and OHSAS 18001 (Occupational Health & Safety) accreditation
- Swish has obtained the responsible sourcing certification BES6001 for all its cellular PVC products. This means that Swish can offer new build customers maximum points under Mat 2 & 3 responsible sourcing sections of the Code for Sustainable Homes.
- National network of Specialist stockists ensures expert local support



Swish Fascias and

White

Swish Jumbo™ boards are strong, load bearing profiles. These boards are secured directly to the rafter foot and fully support the weight of eaves tiles and rainwater systems. A wide range of sizes ensures specifier requirements are met. Soffit boards are available in the form of vented and unvented flat boards and interlocking cladding profiles. A fluted (unvented) board is also available.

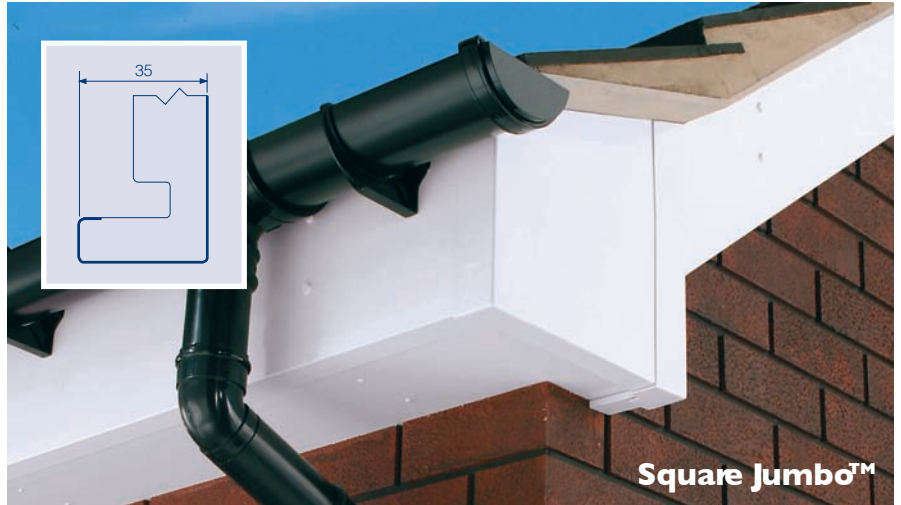

Bargeboards

Foiled

Swish 16mm fascia and 9mm vented and unvented soffit boards match most window and conservatory systems currently in use. Each foiled finish is accompanied by a full compliment of colour matched corners, joints and trims. Swish cladding profiles are also available in foiled finishes (see page 11).

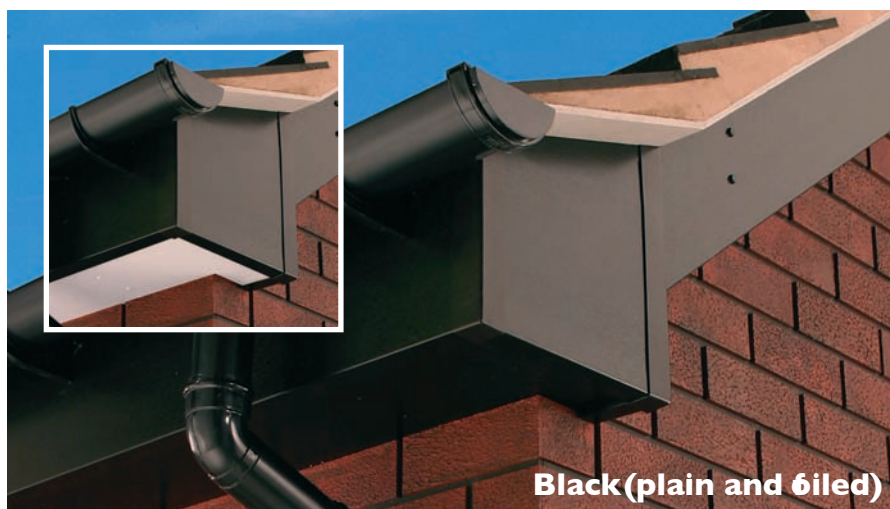

Sustainability

Cellular PVC suits the exposed conditions on clad facades and at the roofline, especially as these areas are difficult and costly to access and maintain.

Swish cellular PVC requires no maintenance; it will last the life-time of the building and can be fully recycled at the end of its service life.

The BRE Green Guide (June 2008) recognises the sustainability of PVC building products. Under the Code for Sustainable Homes, PVC cladding over timber framework is classed as an A+ external wall system; the highest rating available.

Swish cellular PVC offers the potential of a 60+ year, maintenance-free working life, minimising maintenance costs for landlords and home owners alike. This low lifetime cost may free up maintenance budgets for the purchase of other CO₂ reduction materials such as loft insulation.

At the end of their working life, Swish profiles can be easily removed and recycled.

Colour Options

Swish 16mm Square Fascias and 9mm flat Gee Pee™ soffit boards are also available in three PLAIN colours, Anthracite, Light Grey, Hazy Grey and Gale Grey. These profiles have a co-extruded self-coloured outer surface.



Anthracite



Light Grey

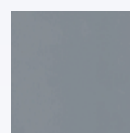

Hazy Grey



Gale Grey

Note The above swatches are not an accurate representation of colour therefore it is recommended that a sample be requested to aid colour matching.

M-Boss

Fascias and Cladding

- Tough 16mm fascia boards do not require a timber backing board
- Will bear the weight of the guttering system and the lower row of tiles
- Use in conjunction with standard soffit boards
- Shiplap cladding design with textured surface on the vertical face.
- Installation requirements are as standard white and coloured profiles
- May be worked with standard carpentry tools
- 10 Year Guarantee on all M-Boss cellular PVC profiles

Trims

- Matching fascia joints and corners with textured surfaces.
- Cladding to be installed using standard cladding trims .

Soffits

- Use with standard Swish soffits
- For the full range of soffit styles and sizes please consult the Swish Trade Price List

Timber Effects

Swish foiled GeePee™ boards and Tudor Board may be used to create low maintenance timber effects to gable ends and dormers.

GeePee™ and Tudor boards are flat profiles. Tudor Boards are 20mm thick and GeePee™ boards 9mm thick. Both are available in Mahogany, Rosewood, Light Oak and Black foiled finishes.

Tudor Board



Tudor Board profiles should be fixed with 2 x 65mm capped screws at minimum of 400mm fixing centres into suitable, secure substrate.

Swish M-Boss, Sof

M-BossRange

Swish M-Boss fascia profiles provide the perfect combination of a traditional timber appearance, with the practical, low maintenance benefits of cellular PVC.

M-Boss fascias are available in a range of standard sizes including a 405mm double-ended board which enables easy box-end construction. The range is complemented by matching M-Boss corners and joints.



M-Boss cladding profiles are available in traditional shiplap design. Standard 150mm version and a 300mm (twin plank) design for rapid installation. Alternating plank design mimics timber.

A selection of standard cladding trims in colours to complement M-Boss cladding panels are available to suit 150mm and 300mm Shiplap panels.



fits and Vents

Soffit Boards and Ventilation

Swish GeePee™ plain soffit boards are 9mm thick and are suitable for either lay-on or angled soffit details. Swish Polo™ ventilated soffit boards are available with slot configurations in either single (10mm) or double rows (25mm). All Polo™ boards are 9mm thick, maximising structural integrity, eliminating bowing and minimising fixing requirements. Open V and Tee Gee™ tongue and groove boards are also available for wide 'feature' soffits.

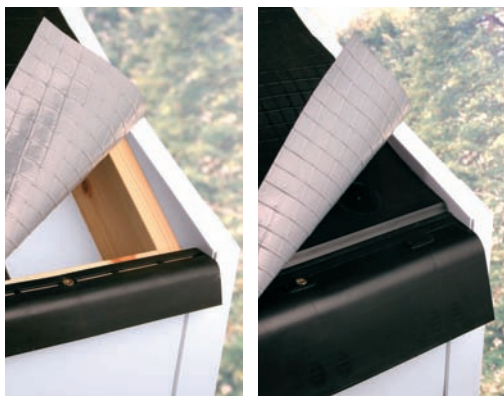

Over Fascia Ventilator

Vented Eaves Protector

Over Fascia Ventilation

Where a 'clean' or unvented soffit is required, ventilation may be provided over the fascia using an Over Fascia Ventilator or a Vented Eaves Protector, fixed securely to the top of the fascia board. The support provided by the vented eaves protector eradicates 'ponding' which may occur behind the fascia board where there is a tendency for the sarking felt to sag. Over-fascia ventilation provides a continuous 10mm air path.

Through Fascia Ventilation

The Polo™ range of ventilated soffit boards provides the equivalent of a 10mm or 25mm air path as required.

Strip ventilators allow additional or alternative means of ventilation to the roof void. These are designed to fit Swish 9mm GeePee™ soffits and are available in both 10mm and 25mm configurations.



Ventilation

Roof voids must be ventilated in order to stop warm air condensing on cold surfaces as condensation encourages rot and mould growth.

Ventilation Options

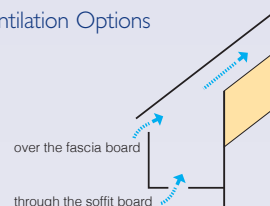

These diagrams show the minimum air path dimensions required under the current Building Regulations

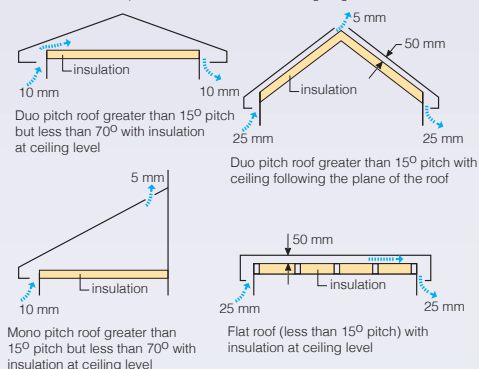

The air path dimensions shown above are the minimum widths required for clear, continuous air spaces.

Compliance with these ventilation standards is required on all buildings, except those constructed without ventilation provision or which pre-date Buildings Regulations. However, Swish recommend that adequate ventilation is provided on all refurbishment projects regardless of age.

Swish ventilators for roof voids are covered by British Board of Agrément Certificate No. 91/2620. When used in accordance with the Certification, Swish ventilators will satisfy all statutory Building Regulations in England, Wales, Scotland and Northern Ireland.



Swish Decorative

The Finishing Touches

The Swish Technical Support team have developed a number of detailing features that allow the designer to achieve an attractive and individual look without sacrificing the benefits of a standardised system.

Decorative Roofline

The decorative edge of these Concave and Convex profiles offers flexibility of design, particularly where the two boards join at the apex. These 16mm thick boards are available in standard 5m lengths and can be fixed direct to rafter ends with no requirement for additional backing timber.



Bespoke designs are possible subject to volume requirements. For further information please contact the Swish Technical Services Team.

Roofstyle

Swish Roofstyle moulded components can be fitted to the face of a bargeboard or to the first rafter. Joints between components self-align and fixings are hidden to enhance appearance. The system includes Concave and Convex clip-together components.



Bargeboards, Spires and Finials

These profiles add traditional character to any building. They combine the high performance, low maintenance characteristics of PVC with lasting good looks and are ideal for both new build and refurbishment projects.

Convex



Concave



Ball Finial & Bracing Bar



RoofSpires - 3 designs

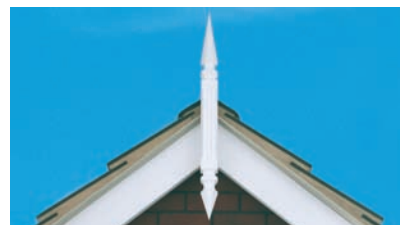

Enhancing the Installation

Swish offers a range of trim profiles that can be used to enhance the look of the installation. A small selection is featured here. Typical applications are at the gable eaves and under the fascia/soffit.

Scotia



Rectangle

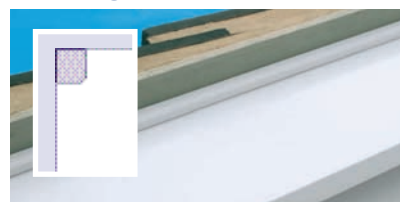

Quadrant

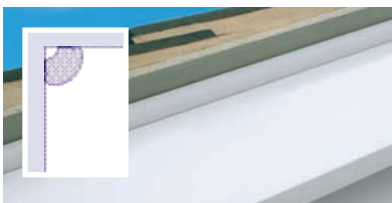

Scotia & 'D' Mould

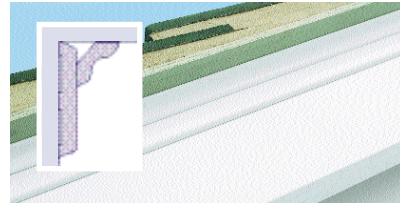

Roofstyle Components



C446 - Convex



C445 - Concave

Elements

Dentils

Decorative Dentil mouldings add elegance to the eaves of any property, creating individual architectural detailing. The range includes a choice of 4 sizes, and differing designs.

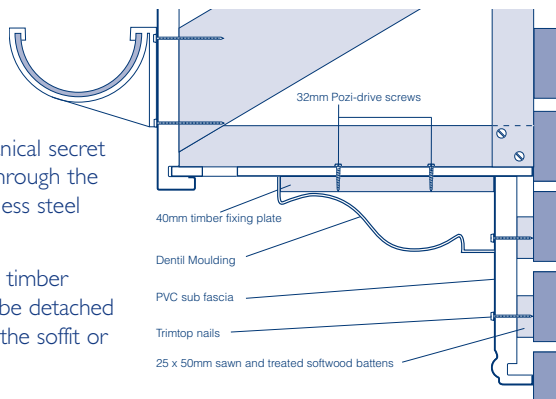

- A strong mechanical secret fix is achieved through the soffit using stainless steel screws.
- Alternatively the timber fixing plate may be detached and screwed to the soffit or wall.

Gallows

Swish Gallows Brackets are load bearing and capable of offering structural support to door and window canopies. The surface pattern mimics the traditional appearance of timber with a high level of bevelling detail.



Feature Corbel

The Feature Corbel has sharply defined sweeping curves which are most effective when installed below a flat top canopy or used in pairs beneath oriel windows.



Dentils

Swish Dentils provide an excellent means of adding both decoration and value to a property.

The range meets the requirements of most new build and refurbishment applications. Each unit is capable of a secret mechanical fix in at least one direction through a built in footplate.

The orientation and spacing are worth careful consideration in order to achieve the best effect. In addition, a continuous sub-fascia of cellular PVC fixed to the wall under the soffit will greatly enhance the effect.

Gallows & Corbel

Swish exterior Gallows Brackets and Feature Corbel offer a stylish yet durable detail to feature under canopies, bay and oriel windows.

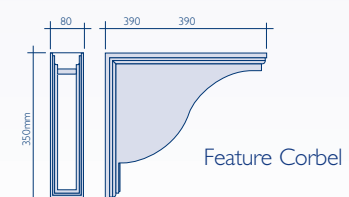
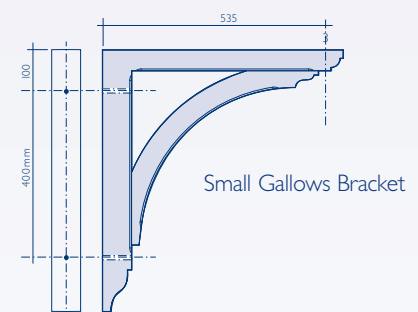
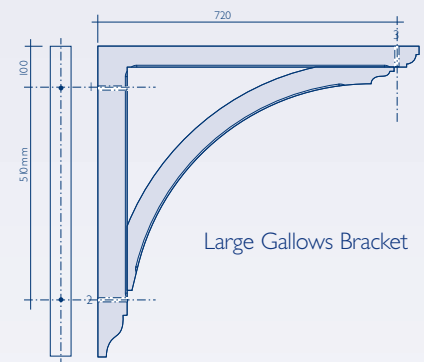

Gutters and Pipes

Gutters and pipes have a core of recycled material which is grey in colour in order to avoid the unnecessary use of additional colouring agents.

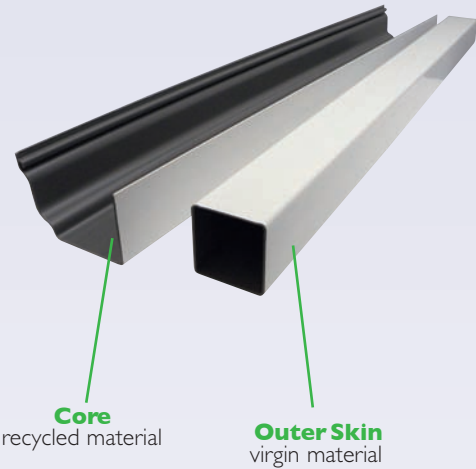

Accessories

Swish Rainwater System accessories are injection moulded using virgin PVC. Components incorporate a simple clip together system for fitting gutter and pipe profiles. Gutter Clips include pre-installed seals that are lubricated during manufacture to ease the clipping process.

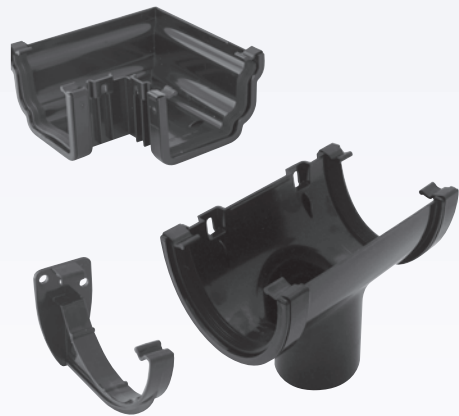

PVC Sustainable R

The System

Swish Rainwater Systems are ideal for those who wish to specify quality products that have a reduced carbon footprint. They are unique in the UK in that they contain a high proportion of post consumer recycled PVC.

Approximately 84% by weight of gutters and pipes is composed of recycled material that is derived from old PVC windows and gutter systems that have been removed from buildings when being refurbished or demolished.

The production of PVC components from recycled material requires a fraction of the energy needed to manufacture virgin PVC and so 70% saving in CO₂ output is made during the production of Swish gutter and pipe profiles when compared to production of 100% virgin material.

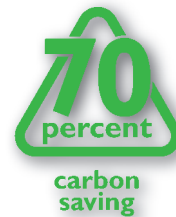
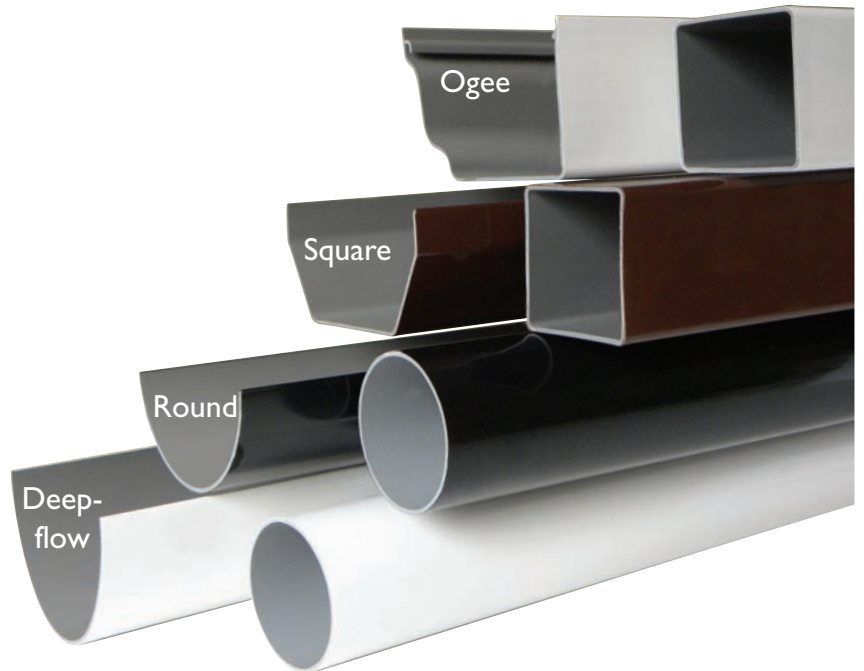

Rainwater Systems

Swish Rainwater Systems are designed for application in most domestic and light commercial properties throughout the UK. Information to assist specifiers determine the basic requirements of a gutter system is available in the Swish Rainwater Design and Installation Guide. Swish Technical Services Dept. can provide further information and guidance as required. For further details please contact them on 01827 317238.



Specification

Performance

Gutter	Flow Rate	Max.area drained
Round	0.9 l/s	43 m ²
Square	1.6 l/s	76 m ²
Ogee	2.2 l/s	105 m ²
Deepflow	1.8 l/s	86 m ²

Colours



Black

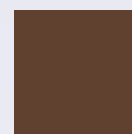

Brown



White

Certification

Swish Rainwater Systems are manufactured to the following standards:-

- Kitemark KM508760
- BS EN 607 : 2004 (Eaves Gutters & Fittings)
- BS EN 12200/1 : 2000 (Plastic Piping Systems)
- BS EN 1462 : 2004 (Brackets for Eaves Gutters)
- ISO 9001 Quality Management System



KM 508760

Swish Cladding



Swish Cladding System

White

Cellular PVC cladding can significantly improve the thermal properties of a building and provides an excellent low maintenance alternative to timber. The Swish cladding system offers excellent colourfastness and considerable design choice.



Versatile Designs

Cellular PVC cladding can be fitted in a variety of patterns including horizontal, herring-bone or diagonal. Some profiles can be mounted vertically.

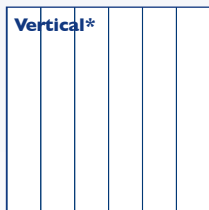
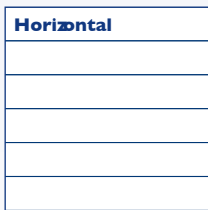

* Tee Gee and Open V only

stems

Foiled

Cladding profiles are commonly used on the cheeks and apex of dormer windows, as a long life replacement for softwood claddings and as a ceiling soffit for large open porches. The Foiled range is compatible with many window and conservatory system colours, and features colour matched trims and joints.



Design Criteria

White Cladding

Battens:	Min. 19 x 38mm. Recommended 25 x 38mm (suits return flange on C027 starter trim and C040 universal channel with batten cover).
Airspace:	Minimum 19mm. Recommended 25mm, with ventilation.
Fixing Centres	600mm max. up to 2 storeys 400mm max. from 2 to 5 storeys.

Coloured & Foiled Cladding

Battens:	Min. 50 x 38mm
Airspace:	Min. 50mm to the rear of the installation. Continuity of the ventilation path should be achieved by omitting the starter batten and by venting into the eaves or leaving a 10mm air gap between the cladding and soffit. Angle ventilators C061 or C065 can be installed at the base and top of the installation to prevent insect ingress.

Fixing Centres: 400mm max.

Note:

Foiled and coloured PVC installations can suffer from excessive expansion and contraction due to heat absorption. Specifiers and installers **MUST** therefore satisfy themselves that sufficient provision has been made to avoid significant thermal movement with the introduction of adequate ventilation behind the installation.

Generally

Fixings:	25mm A4 stainless steel pins (C203) for 19mm battens. 30mm A4 stainless steel pins (C204) for 25mm battens.
----------	--

Breather membrane:- Install over timber frame or in exposed locations.

Insulation incorporated:- Counter batten and include breather membrane. 25mm ventilated airspace must be provided for white, coloured and foiled cladding as above.

Sealing: Use low modulus silicone (C077).

Product Guarantees

All Swish White cellular PVC profiles carry a **20Year** Product Guarantee. All foiled and coloured cellular profiles carry a **10Year** Guarantee.



WARM ROOF
DIVISION